



P-channel -30V, -3A, SOT-23 Trench Power MOSFET 溝槽式功率場效應管

■ Features 特點

Low on-resistance and maximum DC current capability 低導通電阻和最大直流電流能力

Super high density cell design 超高元胞密度設計

$R_{DS(ON)} \leq 70m\Omega @ V_{GS} = -10V$

$R_{DS(ON)} \leq 95m\Omega @ V_{GS} = -4.5V$

■ Applications 應用

Power Management in Note book 筆記本電源管理

Portable Equipment 便攜式設備

Battery Powered System 電池電源系統

DC/DC Converter 直流/直流變換

Load Switch 負載開關應用

■ Internal Schematic Diagram 內部結構

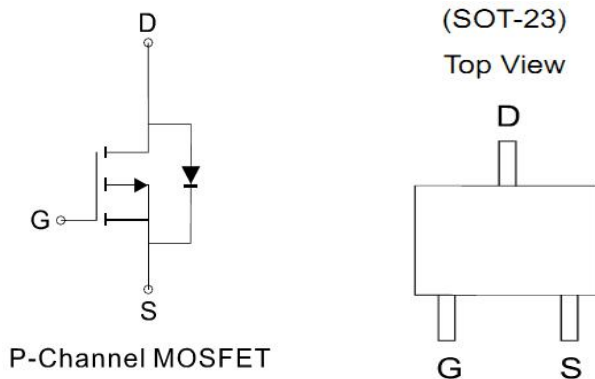

■ Absolute Maximum Ratings 最大額定值

Characteristic 特性參數	Symbol 符號	Rat 額定值	Unit 單位
Drain-Source Voltage 漏極-源極電壓	BV_{DSS}	-30	V
Gate- Source Voltage 柵極-源極電壓	V_{GS}	± 20	V
Drain Current (continuous)漏極電流-連續	I_D (at $T_A = 25^\circ C$)	-3	A
Drain Current (pulsed)漏極電流-脈沖	I_{DM}	-12	A
Total Device Dissipation 總耗散功率	P_{TOT} (at $T_A = 25^\circ C$ at $T_A = 70^\circ C$)	1.04 0.67	W
Thermal Resistance Junction-Ambient 熱阻	$R_{\theta JA}$	120	$^\circ C/W$
Junction/Storage Temperature 結溫/儲存溫度	T_J, T_{stg}	-55~150	$^\circ C$



■ Electrical Characteristics 電特性

($T_A=25^{\circ}\text{C}$ unless otherwise noted 如無特殊說明，溫度為 25°C)

Characteristic 特性參數	Symbol 符號	Min 最小值	Typ 典型值	Max 最大值	Unit 單位
Drain-Source Breakdown Voltage 漏極-源極擊穿電壓($I_D=-250\mu\text{A}, V_{GS}=0\text{V}$)	BV_{DSS}	-30	—	—	V
Gate Threshold Voltage 柵極開后電壓($I_D=-250\mu\text{A}, V_{GS}=V_{DS}$)	$V_{GS(th)}$	-1	—	-3	V
Zero Gate Voltage Drain Current 零柵壓漏極電流($V_{GS}=0\text{V}, V_{DS}=-30\text{V}$)	I_{DSS}	—	—	-1	μA
Gate Body Leakage 柵極漏電流($V_{GS}=\pm 16\text{V}, V_{DS}=0\text{V}$)	I_{GSS}	—	—	± 100	nA
Static Drain-Source On-State Resistance 静态漏源導通電阻($I_D=-3.2\text{A}, V_{GS}=-10\text{V}$) ($I_D=-2.5\text{A}, V_{GS}=-4.5\text{V}$)	$R_{DS(ON)}$	—	58 75	70 95	$\text{m}\Omega$
Diode Forward Voltage Drop 內附二極管正向壓降($I_{SD}=-1\text{A}, V_{GS}=0\text{V}$)	V_{SD}	—	—	-1.2	V
Input Capacitance 輸入電容 ($V_{GS}=0\text{V}, V_{DS}=-15\text{V}, f=1\text{MHz}$)	C_{ISS}	—	460	—	pF
Common Source Output Capacitance 共源輸出電容($V_{GS}=0\text{V}, V_{DS}=-15\text{V}, f=1\text{MHz}$)	C_{OSS}	—	74	—	pF
Reverse Transfer Capacitance 回饋電容 ($V_{GS}=0\text{V}, V_{DS}=-15\text{V}, f=1\text{MHz}$)	C_{RSS}	—	30	—	pF
Gate Source Charge 柵源電荷密度 ($V_{DS}=-15\text{V}, I_D=-1.7\text{A}, V_{GS}=-4.5\text{V}$)	Q_{gs}	—	2.8	—	nC
Gate Drain Charge 柵漏電荷密度 ($V_{DS}=-15\text{V}, I_D=-1.7\text{A}, V_{GS}=-4.5\text{V}$)	Q_{gd}	—	2.3	—	nC
Turn-On Delay Time 開后延遲時間 ($V_{DS}=-15\text{V}, I_D=-1\text{A}, R_{GEN}=6\Omega, V_{GS}=-10\text{V}$)	$t_{d(on)}$	—	33	—	ns
Turn-On Rise Time 開后上升時間 ($V_{DS}=-15\text{V}, I_D=-1\text{A}, R_{GEN}=6\Omega, V_{GS}=-10\text{V}$)	t_r	—	17	—	ns
Turn-Off Delay Time 關断延遲時間 ($V_{DS}=-15\text{V}, I_D=-1\text{A}, R_{GEN}=6\Omega, V_{GS}=-10\text{V}$)	$t_{d(off)}$	—	39	—	ns
Turn-On Fall Time 開后下降時間 ($V_{DS}=-15\text{V}, I_D=-1\text{A}, R_{GEN}=6\Omega, V_{GS}=-10\text{V}$)	t_f	—	5	—	ns

■ TYPICAL CHARACTERISTIC CURVE 典型特性曲线

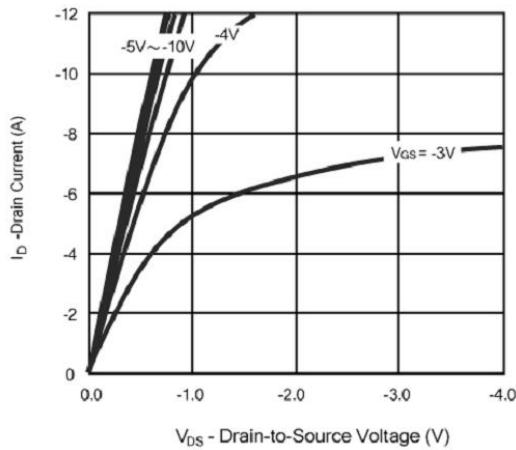

Figure 1. Output Characteristics

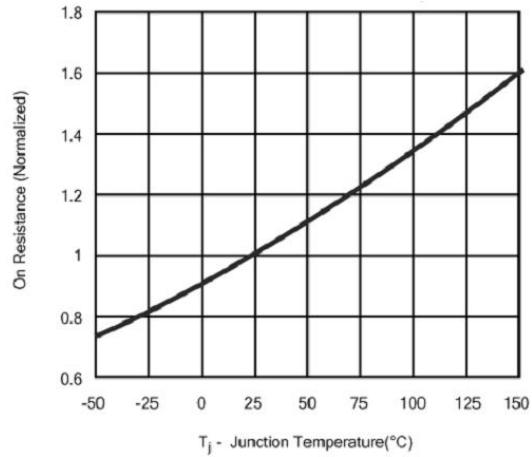

Figure 2. On-Resistance Variation with Temperature

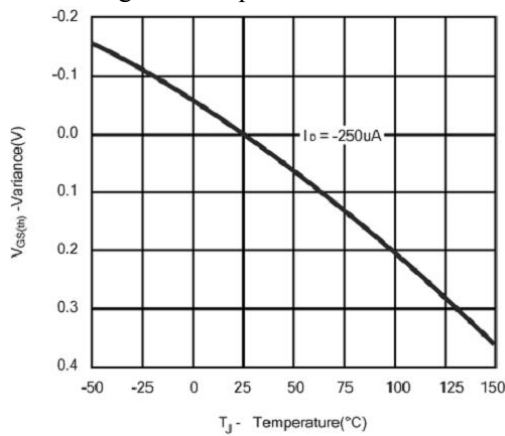

Figure 3. Gate Threshold Variation with Temperatures

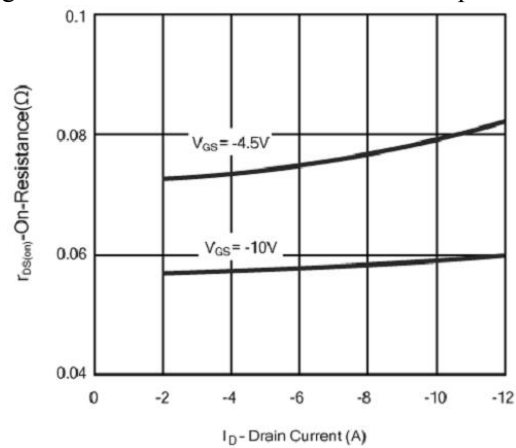

Figure 4. On-Resistance Variation with Drain Current

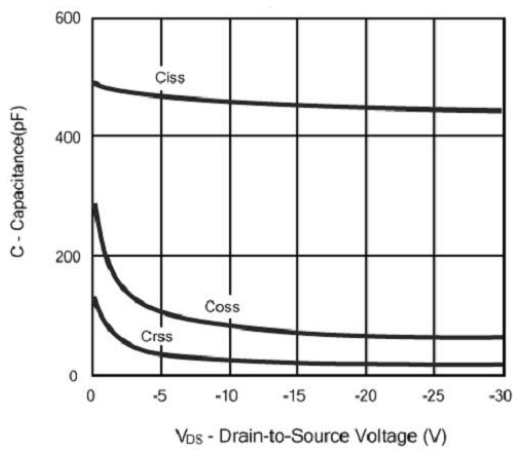

Figure 5. Capacitance Variation with Drain-source Voltage

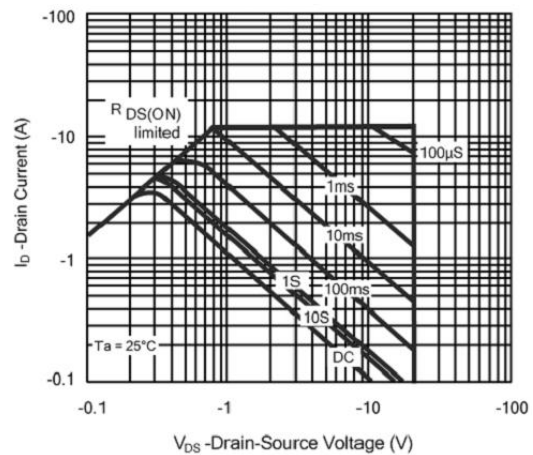

Figure 6. Maximum Safe Operating Area